

Pecco SK 180

TOWER CRANE

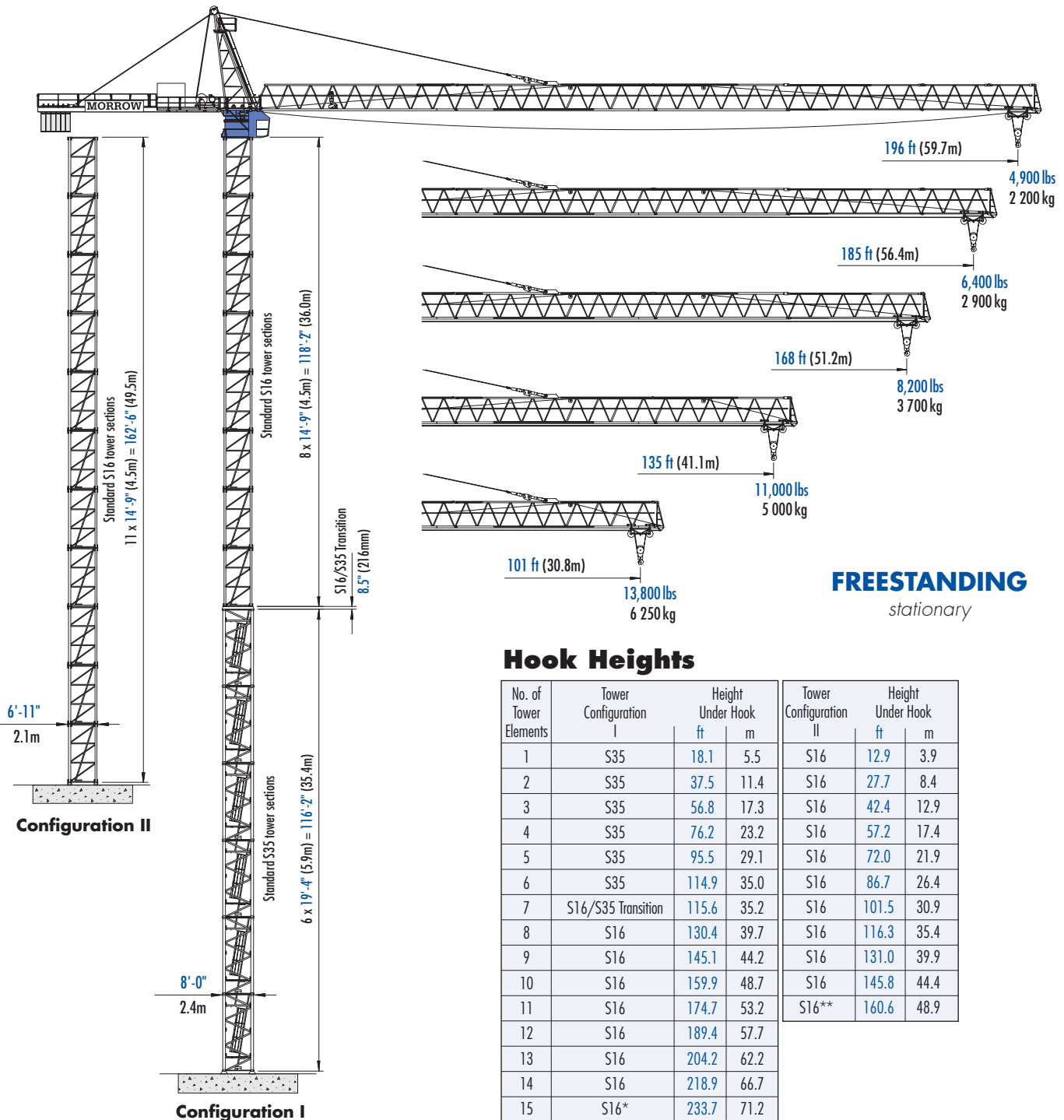

* Remove top climbing unit from crane prior to operating crane at maximum hook height.

** Lower top climbing unit to base of crane prior to operating crane at maximum hook height. Other tower combinations are possible. Contact Morrow Equipment for information.



Morrow Equipment

Tie-in Details

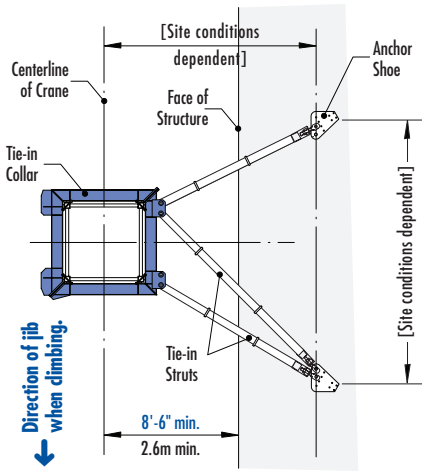

TIE-IN ASSEMBLY

Plan View

IMPORTANT! The tie-in assembly shown is an example of a typical installation when using S16 tower. Please note, however, that factors determining the installation of tie-in assemblies may vary due to project specific requirements. Contact Morrow for information.

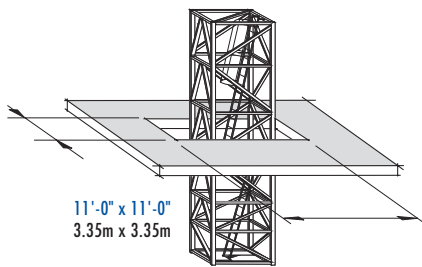

SLAB OPENING

Recommended (S16)

IMPORTANT! Please consult crane's operation manual before erecting, operating, servicing and dismantling crane.

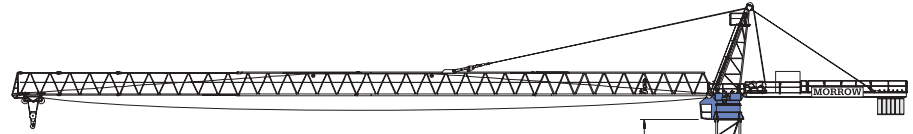

NOTE! If hook height exceeds 330 ft (100m), the number of tower sections above the uppermost tie-in location **MUST** be reduced by 1 tower section.

* Lower the top climbing unit to the uppermost tie-in prior to operating crane at maximum hook height.

Consult Morrow for specific information regarding alternate foundation details, dimensions, tie-in locations, reaction forces and slab openings.

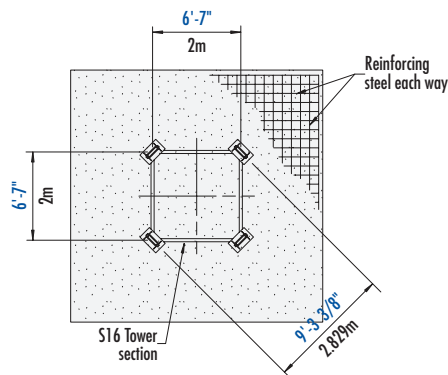
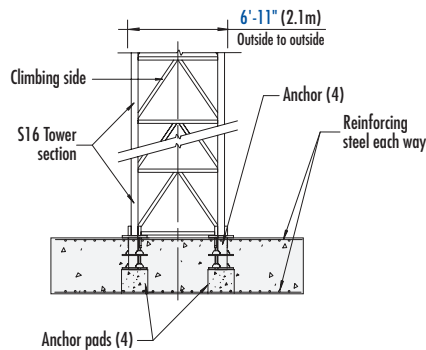

FOUNDATION DETAILS

with S16 Tower

on reinforced concrete footing

137'-11" (42.0m) max.

44'-3" (13.5m) min.
103'-5" (31.5m) max.

128'-0" (39.0m) max.

*Hydraulic Top Climbing Unit

Tie-In Assembly

TOP CLIMBING

with S16 Tower

Tied to Structure

Pecco SK 180

Radius and Capacities for 2-Part operation

Hook Radius	2-Part Line Max Capacity – Radius	ft m	80 24.4	90 27.4	95 29.0	101 30.8	105 32.0	110 33.5	120 36.6	130 39.6	135 41.1	140 42.7	150 45.7	160 48.8	168 51.2	180 54.9	185 56.4	190 57.9	196 59.7
196 ft 59.7m	13,800 lbs – 81 ft 6 250 kg – 24.7m	lbs kg	13,800 6 250	12,300 5 580	11,700 5 310	10,800 4 900	10,320 4 680	9,700 4 400	8,700 3 950	8,000 3 630	7,700 3 490	7,300 3 310	6,700 3 040	6,200 2 810	5,800 2 630	5,400 2 450	5,200 2 360	5,100 2 310	4,900 2 200
185 ft 56.4m	13,800 lbs – 95 ft 6 250 kg – 29.0m	lbs kg	13,800 6 250	13,800 6 250	13,800 6 250	12,900 5 810	12,420 5 630	11,800 5 350	10,700 4 850	9,700 4 400	9,300 4 220	8,800 3 990	8,200 3 720	7,600 3 450	7,200 3 270	6,600 2 990	6,400 2 900		
168 ft 51.2m	13,800 lbs – 106 ft 6 250 kg – 32.3m	lbs kg	13,800 6 250	13,800 6 250	13,800 6 250	13,800 6 250	13,800 6 250	13,300 6 030	12,100 5 490	11,000 4 990	10,600 4 810	10,100 4 580	9,300 4 220	8,600 3 900	8,200 3 700				
135 ft 41.1m	13,800 lbs – 110 ft 6 250 kg – 33.5m	lbs kg	13,800 6 250	13,800 6 250	13,800 6 250	13,800 6 250	13,800 6 250	13,800 6 250	12,600 5 720	11,500 5 220	11,000 5 000								
101 ft 30.8m	13,800 lbs – 101 ft 6 250 kg – 30.8m	lbs kg	13,800 6 250	13,800 6 250	13,800 6 250	13,800 6 250													

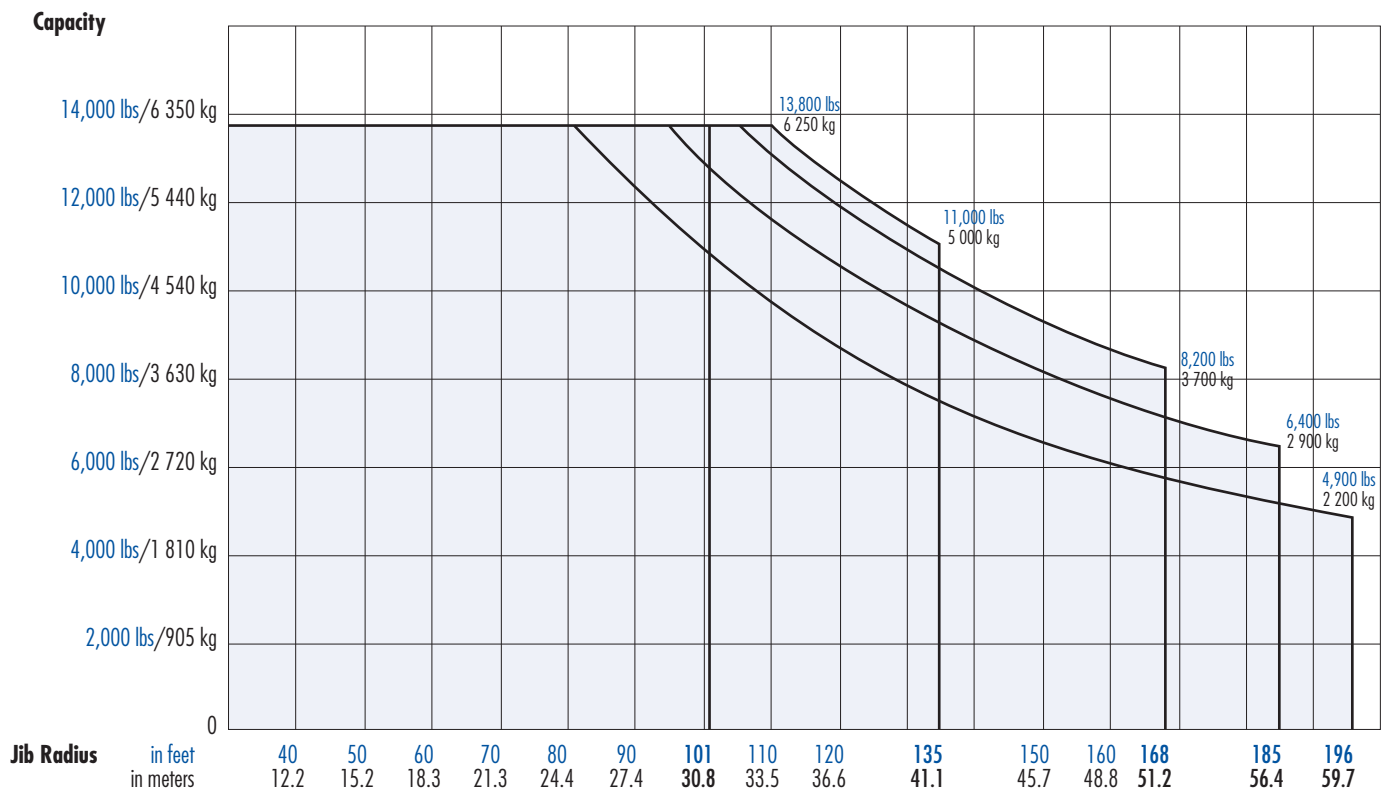

Pecco SK 180

Radius and Capacities for 4-Part operation

Hook Radius	4-Part Line Max Capacity – Radius	ft m	60 18.3	70 21.3	80 24.4	90 27.4	101 30.8	110 33.5	120 36.6	130 39.6	135 41.1	140 42.7	150 45.7	160 48.8	168 51.2	180 54.9	185 56.4	190 57.9	196 59.7
196 ft 59.7m	27,600 lbs – 43 ft 12 500 kg – 13.2m	lbs kg	19,060 8 650	15,700 7 120	13,400 6 080	11,700 5 310	10,200 4 630	9,000 4 080	8,100 3 670	7,300 3 310	7,000 3 180	6,700 3 040	6,100 2 770	5,600 2 540	5,200 2 360	4,700 2 130	4,500 2 040	4,300 1 950	4,200 1 900
185 ft 56.4m	27,600 lbs – 51 ft 12 500 kg – 15.5m	lbs kg	22,720 10 310	18,900 8 570	16,200 7 350	14,200 6 440	12,300 5 580	11,000 4 990	9,800 4 450	9,000 4 080	8,600 3 900	8,200 3 720	7,500 3 400	7,000 3 180	6,600 2 990	5,900 2 680	5,700 2 600		
168 ft 51.2m	27,600 lbs – 57 ft 12 500 kg – 17.2m	lbs kg	25,750 11 680	21,300 9 660	18,300 8 300	16,100 7 300	14,100 6 400	12,700 5 760	11,400 5 170	10,400 4 720	9,900 4 490	9,400 4 260	8,600 3 900	7,900 3 580	7,500 3 400				
135 ft 41.1m	27,600 lbs – 58.5 ft 12 500 kg – 17.8m	lbs kg	26,750 12 130	22,300 10,120	19,300 8 750	16,800 7 620	14,600 6 620	13,200 5 990	11,900 5 400	10,800 4 900	10,400 4 700								
101 ft 30.8m	27,600 lbs – 59 ft 12 500 kg – 18.0m	lbs kg	27,150 12 320	22,600 10 250	19,600 8 890	17,000 7 710	14,800 6 700												

Capacity

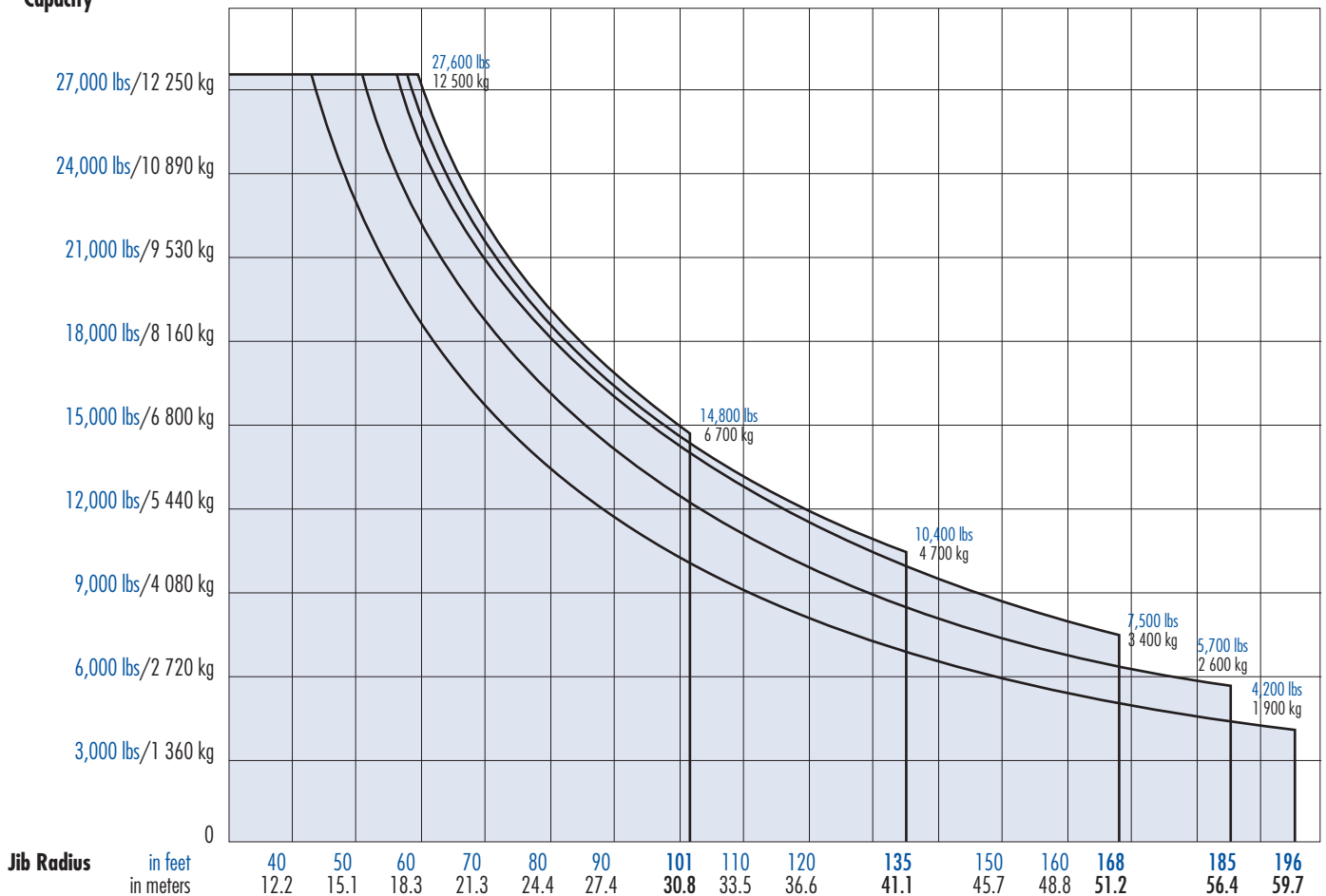

Hoist Speed and Capacity

Hoist Unit	2-Part Line				
	Gear	Capacity	Line Speed	Capacity	Line Speed
105 hp (78 kW) AC hoist unit 4-speed gearbox Remote-controlled gear shifting Eddy current brake 2P130 4P65	1	up to 13,800 lbs	@ 112 fpm	up to 6 250 kg	@ 34 m/min
	2	up to 13,800 lbs	@ 178 fpm	up to 6 250 kg	@ 54 m/min
	3	up to 9,260 lbs	@ 282 fpm	up to 4 200 kg	@ 86 m/min
	4	up to 5,500 lbs	@ 440 fpm	up to 2 500 kg	@ 134 m/min
	4-Part Line				
	1	up to 27,600 lbs	@ 56 fpm	up to 12 500 kg	@ 17 m/min
	2	up to 27,600 lbs	@ 89 fpm	up to 12 500 kg	@ 27 m/min
	3	up to 18,520 lbs	@ 141 fpm	up to 8 400 kg	@ 43 m/min
	4	up to 11,000 lbs	@ 220 fpm	up to 5 000 kg	@ 67 m/min

NOTE! Capacities and line speeds indicated will vary depending on the amount of hoist rope installed. This crane model may be equipped with a hoist unit other than that specified in the data above. To verify, check the serial number of the crane and refer to the Pecco SK 180 Operation Manual for additional information.

Motor Information

Drive Unit	Horsepower	Kilowatts	Speed	
Trolley (2-part line)	6.4 hp	4.8 kW	13 – 249 fpm	4 – 76 m/min
Trolley (4-part line)	6.4 hp	4.8 kW	6.6 – 125 fpm	2 – 38 m/min
Swing	2 x 6.4 hp	2 x 4.8 kW	1 rpm	











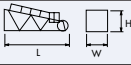
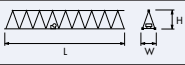

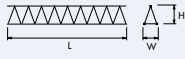

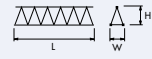

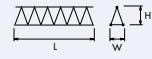





Power Requirements

- 480 V phase-phase, 277 V each phase to ground with 120° phase shift between phases. **Do not use Open Delta transformer.**
- 3-phase, 60 Hz power supply plus ground wire.
- Static configuration: 250 Amp service.

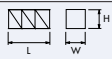
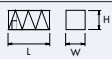
Specifications subject to change without notice. For other configurations and specifications, contact Morrow Equipment.

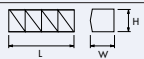
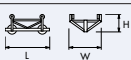
Component List

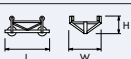
NOTE! Weights and dimensions are approximate. Scale all components before installing. Please consult Pecco SK 180 Operation Manual before erecting, operating, servicing and dismantling crane or crane components. Specifications are subject to change without prior notification. Contact Morrow Equipment for information.

Description	Dimensions L x W x H	Weight	Description	Dimensions L x W x H	Weight
Tower Top 	27'-4" x 6'-7" x 8'-5" 8.3m x 2.0m x 2.57m	3,800 lbs 1 725 kg	Jib Section ① 	50'-10" x 6'-2" x 8'-0" 15.5m x 1.89m x 2.43m	6,400 lbs 2 905 kg
Turntable (Complete) Upper & Lower Part 	9'-2" x 8'-5" x 8'-1" 2.79m x 2.57m x 2.47m	14,500 lbs 6 575 kg	Jib Section ② 	51'-2" x 5'-7" x 7'-4" 15.6m x 1.69m x 2.24m	5,500 lbs 2 495 kg
Turntable Upper Part ¹ 	9'-2" x 8'-4" x 4'-6" 2.79m x 2.55m x 1.38m	6,900 lbs 3 130 kg	Jib Section ③ 	34'-5" x 5'-7" x 6'-8" 10.5m x 1.69m x 2.03m	2,800 lbs 1 270 kg
Turntable Lower Part ² 	8'-6" x 8'-5" x 3'-7" 2.6m x 2.57m x 1.1m	7,600 lbs 3 450 kg	Jib Section ④ 	34'-5" x 5'-6" x 6'-7" 10.5m x 1.68m x 2.02m	1,900 lbs 860 kg
Operator's Cab 	5'-4" x 3'-8" x 6'-7" 1.62m x 1.12m x 2.0m	900 lbs 410 kg	Jib Section ⑤ 	17'-8" x 5'-6" x 7'-0" 5.38m x 1.68m x 2.14m	1,000 lbs 455 kg
Cab Access Platform 	8'-8" x 8'-3" x 5'-3" 2.65m x 2.52m x 1.6m	1,000 lbs 455 kg	Jib Section ⑥ 	12'-2" x 5'-7" x 6'-8" 3.71m x 1.7m x 2.03m	800 lbs 365 kg
Counterjib ⁴ (Complete) 	46'-4" x 5'-11" x 7'-4" 14.1m x 1.8m x 2.23m	16,500 lbs 7 485 kg	Jib Section ⑦ 	2'-9" x 6'-1" x 7'-5" 0.85m x 1.86m x 2.26m	450 lbs 205 kg
Hoist Unit with Frame ³ (105 hp/78 kW) 	8'-4" x 5'-1" x 3'-6" 2.54m x 1.55m x 1.07m	5,800 lbs 2 630 kg	Jib Assembly ⁵ 196-ft (59.7m) ①②③④⑤⑥⑦	197'-4" x 6'-2" x 8'-0" 60.15m x 1.89m x 2.43m	21,350 lbs 9 685 kg
Counterweight Block A 	8'-0" x 1'-2" x 7'-0" 2.45m x 0.35m x 2.13m	7,715 lbs 3 500 kg	Jib Assembly ⁵ 185-ft (56.4m) ①②③④⑤⑦	186'-2" x 6'-2" x 8'-0" 56.75m x 1.89m x 2.43m	19,550 lbs 8 870 kg
Counterweight Block B 	4'-6" x 1'-2" x 4'-8" 1.38m x 0.35m x 1.42m	3,305 lbs 1 500 kg	Jib Assembly ⁵ 168-ft (51.2m) ①②③④⑦	169'-5" x 6'-2" x 8'-0" 51.65m x 1.89m x 2.43m	18,550 lbs 8 415 kg
Tower Section S16 	14'-11" x 7'-7" x 7'-7" 4.55m x 2.3m x 2.3m	5,500 lbs 2 500 kg	Jib Assembly ⁵ 135-ft (41.1m) ①②③⑦	136'-0" x 6'-2" x 8'-0" 41.45m x 1.89m x 2.43m	16,650 lbs 7 550 kg
Tower Section S35 	19'-5" x 7'-10" x 8'-0" 5.92m x 2.4m x 2.44m	8,900 lbs 4 040 kg	Jib Assembly ⁵ 101-ft (30.8m) ①②⑦	102'-6" x 6'-2" x 8'-0" 31.25m x 1.89m x 2.43m	15,035 lbs 6 820 kg
Transition Section S16/S35 	8'-1" x 7'-9" x 1'-1" 2.46m x 2.36m x 0.33m	1,610 lbs 730 kg	Top Climbing Unit with Hydraulics (S16) 	23'-6" x 9'-9" x 9'-3" 7.16m x 2.97m x 2.82m	13,200 lbs 5 990 kg
2-Part Trolley 	6'-7" x 6'-3" x 3'-2" 2.0m x 1.9m x 0.97m	750 lbs 340 kg	Hook Block 2-Part 	2'-2" x 1'-0" x 3'-8" 0.66m x 0.3m x 1.12m	800 lbs 365 kg
4-Part Trolley 	7'-4" x 6'-5" x 3'-3" 2.24m x 1.96m x 1.0m	1,100 lbs 500 kg	Hook Block 4-Part 	1'-9" x 11" x 4'-6" 0.53m x 0.27m x 1.37m	900 lbs 410 kg

¹ Turntable Upper Part includes swing motors. Does not include slewing ring and slewing ring support.

² Turntable Lower Part includes slewing ring and slewing ring support. Does not include Upper Part and swing motors.

³ Does not include wire rope.

⁴ Includes 105 hp (78 kW) hoist unit with frame, electrical panel, handrails and suspension. Does not include wire rope.

⁵ Jib Assemblies include jib sections, pendant cables, trolley drive unit, trolley wire rope, 2-part trolley and hook block. If 4-part application is used, weight increases by 450 lbs (205 kg) for 4-part trolley and hook block.



Morrow Equipment

COMPANY, L. L. C.

3218 Pringle Road SE • P O Box 3306 • Salem, Oregon 97302-0306 USA
503.585.5721 • Fax 503.363.1172 • www.morrow.com • info@morrow.com

The American home of
LIEBHERR
TOWER CRANES

Atlanta, GA • Myrtle Beach, SC • Chicago, IL • Denver, CO • Honolulu, HI • Houston, TX • Los Angeles, CA • Las Vegas, NV • Millwood, NY
Milwaukee, WI • St. Louis, MO • San Francisco, CA • Dallas, TX • Seattle, WA • Miami, FL • Pensacola, FL • Tampa, FL • Washington, DC
Sydney, Australia • Brisbane, Australia • Wellington, New Zealand • Auckland, New Zealand • Vancouver, Canada • Toronto, Canada • Mexico City, Mexico